

August®

User Manual

CR235



August International Ltd
Rawmec Business Park
Hoddesdon EN11 0EE
United Kingdom
Tel: +44(0) 845 250 0586

EU Distributor:
Daffodil Germany GmbH
Bayernstr. 10
D-30855 Langenhagen
Germany
Tel: +49 (0) 511 97812978

www.augustint.com

EN Bluetooth FM & MP3 Wireless Transmitter Car Adaptor

FR Transmetteur sans fil Bluetooth FM & MP3 Adaptateur voiture

DE Kabelloser Bluetooth FM & MP3 Sender

IT Trasmettitore wireless Bluetooth FM e adattatore MP3 per auto

ES Transmisor inalámbrico Bluetooth FM y MP3 Adaptador para coche

PL Bezprzewodowy nadajnik samochodowy Bluetooth FM i MP3

User Manual

Thank you for purchasing the August CR235 Bluetooth FM & MP3 Wireless Transmitter Car Adaptor. This user manual is designed to familiarize you with all the features of this device. Please take the time to read this user manual carefully, even if you are already familiar with a similar product.

Safety

To ensure the safety of you and others, please read the Safety Instructions before using this device. Please do not disassemble the product, it can be unsafe and will invalidate the manufacturer's warranty.

Disposal

Please ensure the product and accessories are disposed of in compliance with the WEEE (Waste Electrical and Electronic Equipment) Directive and any other regulations applicable to your country. Always check with the environment agency and any other relevant authorities for current disposal regulations.

Declaration of Conformity





The Declaration of Conformity can be found on our website at <http://augustint.com/en/declaration/>

Customer Service

You can contact us by phone on: +44 (0)845 250 0586 or by email at: service@augustint.com should you require further technical support or customer service.

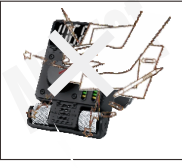

1. Safety Instructions

■ Storage and Use

 <p>Do not store or use this device in extreme temperatures.</p>	 <p>Do not store or use this device in wet or damp environments.</p>
 <p>Do not expose this device to dust, oil or smoke.</p>	 <p>Do not drop or strike this device.</p>
 <p>When transporting this device store securely to avoid impact damage.</p>	 <p>Do not scratch this device with sharp objects.</p>

■ Maintenance

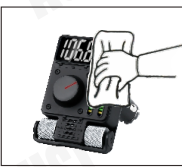
Please unplug all leads before cleaning this device.

 <p>Wipe the device and buttons with a soft cloth.</p>	 <p>Never wipe this device with an abrasive cloth or apply detergent, alcohol or chemical based cleaning products.</p>
---	--

2. Main Features

- Wirelessly Connect Mobile Phone to Car Stereo
- Instant Hands-Free Calling Activation
- Powered USB-C Fast Charge Output
- Easily Accessible Buttons
- MP3 USB Input Playback

3. Box Contents



CR235



User Manual

4. Part Names and Functions

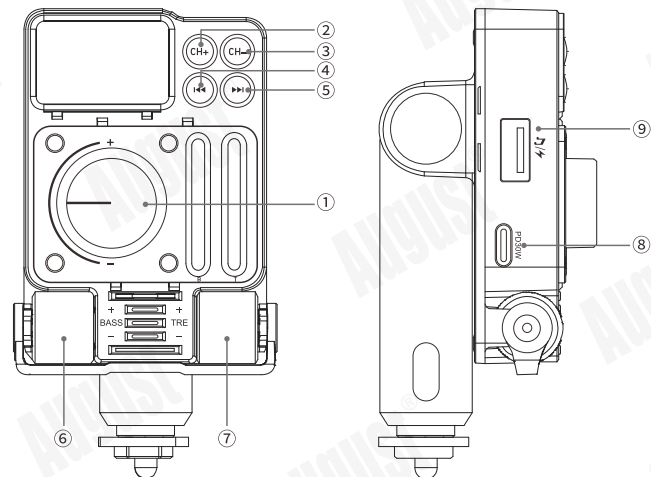

(1) Multifunction Dial

Phone Call:

1. Press once to answer a call, press again to hang up the call.
2. Press and hold for 2 seconds to reject an incoming call.
3. During a call, press and hold for 2 seconds to switch private calling.

Music Playback:

1. Press once to play / pause music.
2. Rotate counterclockwise to decrease volume, rotate clockwise to increase volume.

Siri & Google Assistants:

1. Double click to activate Siri & Google assistants.
2. Press and hold for 2 seconds to turn off the device and reserve charging function.

(2) Channel Increase

Press to increase the FM broadcasting frequency.

(3) Channel Decrease

Press to decrease the FM broadcasting frequency.

(4) Previous

1. Press to go to previous song.
2. Press and hold to turn off LED Effect.

(5) Next

1. Press to go to next song.
2. Press and hold to switch music source from Bluetooth or USB drive.

(6) Bass EQ

1. Rotate the roller upward to increase Bass effect.
2. Rotate the roller downward to decrease Bass effect.

(7) Treble EQ

1. Rotate the roller upward to increase Treble effect.
2. Rotate the roller downward to decrease Treble effect.

(8) USB-C Charging Port

USB-C Charging Port (PD30W): 5V/9V/3A, 12V/2.5A.

(9) USB Reader/ Charging Port

USB-A Port for reading music & 5V/2.4A charging Output.

Note: The maximum allowed capacity for USB drive is 32 GB.

5. Operation

5.1 Power

Insert the CR235 INTO A 12/24V car cigarette socket, the CR235 will switch on automatically. Press and hold the multifunction dial to turn the device off or on.

Note: The CR235 will automatically switch off after 10 minutes if it is not connected to a Bluetooth device.

5.2 Bluetooth Connection

1. Once switched on, the CR235 will enter pairing mode automatically.
2. Enable Bluetooth on your mobile device.
3. Scan for Bluetooth devices on your mobile device and select CR235 to connect to it.

Note: when switched on, the CR235 will reconnect to any previous known device automatically. To pair to a new device, disconnect the existing connection and repeat steps 2-3.

5.3 FM Transmission

The display screen shows the current FM transmission's frequency. Match your FM radio to this frequency to begin playback through your car stereo.

To reduce interference, find an empty station on your FM radio then use CH+ and CH- to match this frequency on the CR235.

5.4 Music Control

Turn the multifunction dial to adjust the volume.
 Press the multifunction dial to play / pause the track.
 Press NEXT to go to the next track.
 Press PREV to go to previous track.
 Rotate the left roller to adjust the Bass effect.
 Rotate the right roller to adjust the Treble effect.

5.5 Hands-free Calling

Whilst connected to your mobile phone, the CR235 will act as a hands-free system for phone calls.

Short press the multifunction dial to answer the incoming call or hang up a call.

Press and hold the multifunction dial for 2 seconds to reject the incoming call in Bluetooth calling mode.

During a call, press and hold 2 seconds the multifunction dial to switch private calling

5.6 Charging Output

Whilst the CR235 is connected to a 12V-24 car cigarette socket, the USB-C and USB-A socket can be used to charge portable device.

6.Troubleshooting

Problem	Solutions
No sound	<ul style="list-style-type: none"> • Check the volume on the radio, FM transmitter and the external device. <p>Connecting via Bluetooth</p> <ul style="list-style-type: none"> • Check the Bluetooth connection <p>Audio cable connection</p> <ul style="list-style-type: none"> • Make sure that the cable is undamaged and properly connected. <p>USB drive</p> <ul style="list-style-type: none"> • Check that the USB drive works and that there are MP3 files in it. The maximum compatible capacity for USB drive is 32 GB. • Check that the frequency on the FM transmitter is the same as that on the car radio.
The FM transmitter display is black.	Check that the FM transmitter is plugged properly in the 12 V car socket.

7. Specifications

Bluetooth Version	5.3
Bluetooth Distance	8m
Frequency Range	87.5-108.0Mhz
Frequency Stability	±10ppm
Input	12-24V
Output	PD30W+5V/2.4A
USB Support (max Capacity)	32GB
Music Format	MP3,WMA,APE,FLAC,WAV

8. Warranty

This product is guaranteed for twelve months from the date of the original purchase. In the unlikely event of any defect arising due to faulty materials or workmanship, the unit will be either replaced or repaired free of charge (where possible) during this period. An alternative product will be offered in case the product is no longer available or repairable.

This warranty is subject to the following conditions:

- The warranty is only valid within the country where the product is purchased.
- The product must be correctly installed and operated in accordance to the instructions given in this user manual.
- The product must be used solely for domestic purposes.
- The warranty only covers the main unit, and does not cover the accessories.
- The warranty does not cover the damage caused by misuse, negligence, accident and natural disaster.
- The warranty will be rendered invalid if the product is resold or has been damaged by inexpert repairs. The manufactures disclaim any liability for incidental or consequential damages.
- Please consult our customer adviser before returning any product; we are not responsible for any unexpected product returns.
- Any faulty product must be kept and returned in the original packaging with all the accessories and the original copy of the purchase receipt.

The warranty is in addition to, and does not diminish, your statutory or legal rights.

Customer Service:

Telephone: +44(0)845 250 0586

Email: service@augustint.com

This product is in compliance with the essential requirements and other relevant provisions of Directive 2014/53/EU. The Declaration of conformity may be consulted online at <http://www.augustint.com/en/declaration>



Industry Canada Statement

This device complies with Industry Canada license-exempt RSS standard(s). Operation is subject to the following two conditions: (1) this device may not cause interference, and (2) this device must accept interference, including interference that may cause undesired operation of the device.

Note: This equipment has been tested and found to comply with the limits for a Class B digital device, pursuant to part 15 of the FCC Rules. These limits are designed to provide reasonable protection against harmful interference in a residential installation. This equipment generates, uses, and can radiate radio frequency energy. Therefore, if not installed and used in accordance with the instructions, may cause harmful interference to radio communications. However, there is no guarantee that interference will not occur in a particular installation. If this equipment does cause harmful interference to radio or television reception, which can be determined by turning the equipment off and on, the user is encouraged to try to correct the interference by one or more of the following measures:

- Reorientate or relocate the receiving antenna.
- Increase the separation between the equipment and receiver.
- Connect the equipment into an outlet on a circuit different from that to which the receiver is connected.
- Consult the dealer or an experienced radio/TV technician for help.

No Unauthorized Modifications: Do not make any changes or modifications to this product without the prior express written approval of August International Ltd. Any changes or modifications made without express written approval could void the user's authority to operate this product.



For further details of relevant technical standards, please contact us at the address on the following back page.